

1 Screw the tube in the hole of the pool.

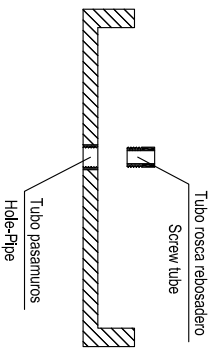

2 Place the pump inside the pedestal.
Remove the power cord through the hole provided
Fill with water half way up the pedestal

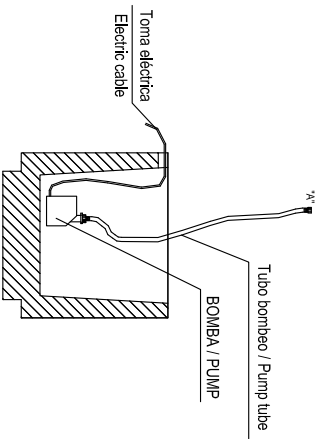

3 Place the pool on the pedestal. The pump tube must pass through the pool as shown in the fig.

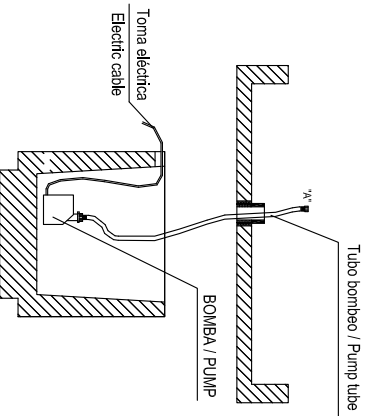

4 Place the top on the pool.
The pumping tube must be connected to the planned coronation by connecting "A" - "A".

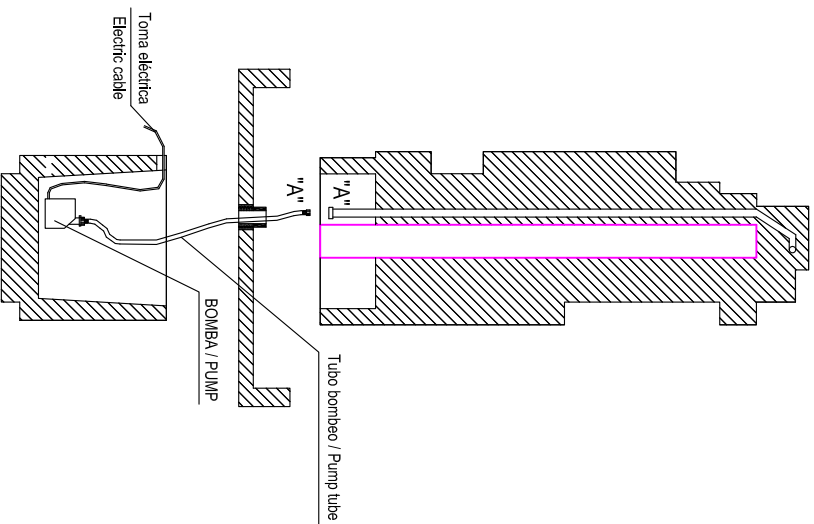

5 Slide the clear tube through the interior provided under the coronation.

CILINDRO TRANSPARENTE

Clear tube

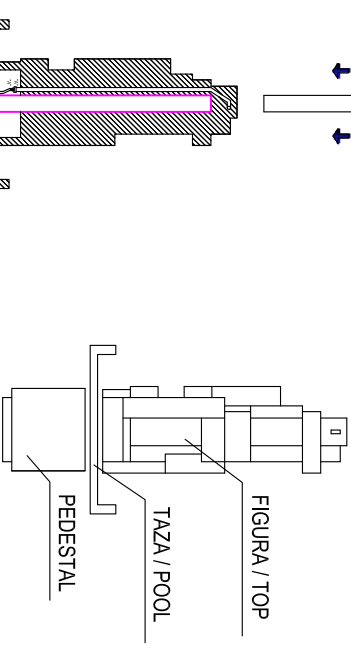
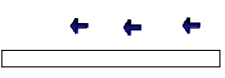

Adjust the tap to the terminal supplier, using Teflon supplied.

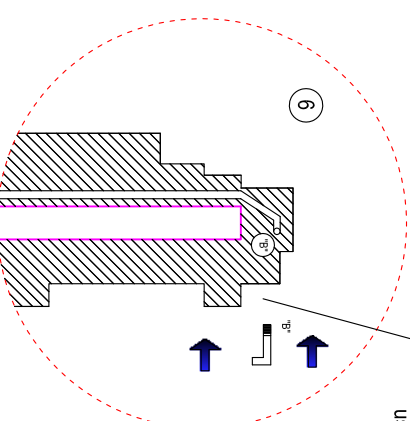

CAUTION:

- Carried out by two or more workers.
- Use of crane.
- Use of safety shoes, helmet, gloves and goggles.
- The surface should be firm and level.
- Assembly adhesives should be used for connecting different fountain modules, tile adhesive or similar.
- The pump has a manhole cover to filter impurities from the water, you should periodically remove and rinse it